

EN

# CT-DECT Multi M7

for Plasser and Theurer S-7.5.41C

**STANDARD** profile

for use as a standard device in a DECT group

## Operating manual

Software-Package: S-MULTI-03-004  
ProfilSet: PSET-MULTI-WC.PUT-003  
P-MULTI-STD.PUT-001

# Contents

1	Safety notices.....	5
2	Introduction .....	6
3	Applications.....	8
3.1	Application: DECT group consisting of CT-DECT Multi M7 .....	8
3.2	Application: DECT group with CT-DECT Case M7 .....	9
4	Operation .....	10
4.1	Controls.....	10
4.2	Plug connectors .....	12
4.2.1	Connecting.....	12
4.2.2	Disconnecting .....	14
4.3	Power on.....	15
4.4	Power off.....	15
4.5	Muting the microphone.....	15
4.6	Earpiece volume .....	16
4.7	PTT function.....	17
4.8	Menu control .....	18
5	Changing the profile .....	20
6	Menu .....	22
7	Subscribing DECT.....	23
7.1	Subscribing consecutively.....	24
7.2	Maximum group size .....	24
8	CT-WirelessPTT MIL.....	25
8.1	Controls.....	25
8.2	Switching on the WirelessPTT function.....	26
8.3	Pairing.....	27
8.4	Delete pairings .....	27



9	Bluetooth® connection .....	28
9.1	Selecting a Bluetooth® device type .....	29
9.2	Connecting a Bluetooth® device (pairing) .....	30
9.3	Phone call control.....	31
9.3.1	Answering an incoming call .....	31
9.3.2	Rejecting an incoming call .....	31
9.3.3	Ending an existing call .....	32
9.3.4	Activating automatic call acceptance .....	32
10	Internal power supply .....	33
10.1	Using AAA adapters.....	33
10.2	Changing the batteries / AAA adapters.....	35
10.3	Runtime.....	36
10.4	Battery level monitoring.....	37
10.5	Visual battery status indicator (status LED) .....	38
10.6	Acoustic battery warning.....	38
10.7	Automatic shutdown in case of undervoltage.....	39
11	Accessories.....	40
12	Maintenance and care.....	41
12.1	Inspecting devices.....	41
12.2	Cleaning .....	41
13	Labeling.....	42
14	Abbreviations and terms .....	43





# 1 Safety notices

## **DANGER**

Immediate hazardous situation. Results in death or serious injury.

## **WARNING**

Potentially hazardous situation. May result in death or serious injury.

## **CAUTION**

Potentially hazardous situation with minor or moderate injury.

## **NOTICE**

Indicates a situation that, if not avoided, may cause damage to the product or other property. Used to indicate useful information for efficient and safe use of the product.

### *Legal notice for operation in the European Union*

The transmitter of the CT-DECT device may only be used in the European Union when it has the following label:



## 2 Introduction

The CT-DECT Multi M7 is a mobile communication device based on DECT radio technology. It enables the user to connect wirelessly to other users in a DECT group.

All participants can talk to each other in full duplex. This means that they can communicate hands-free without pressing a button.

The CT-DECT Multi M7 is used together with a headset. Wired CeoTronics headsets can be connected as well as wireless headsets (via Bluetooth®).

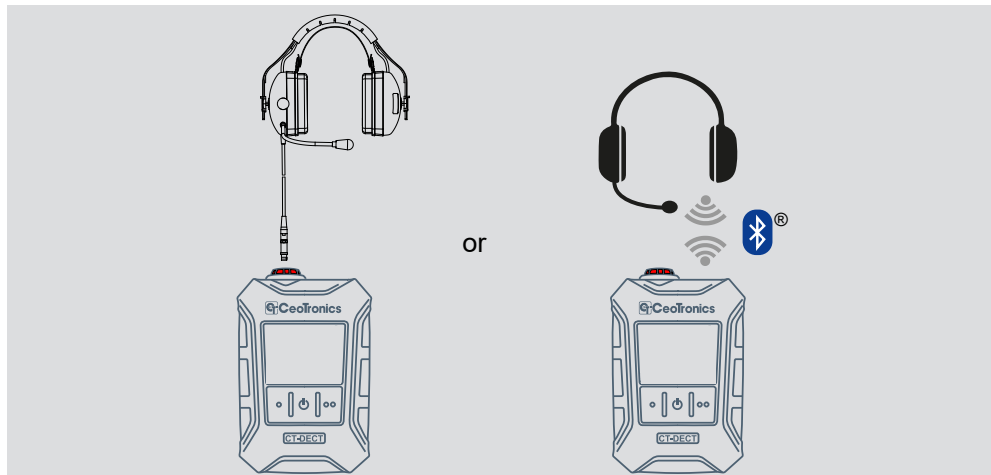

A DECT group always includes a base device, also known as a FixPart (FP), and at least one standard device, also known as a PortablePart (PP).

CT-DECT Multi M7 or CT-DECT Case M7 can be used as the base device.

### DECT group with CT-DECT Multi M7

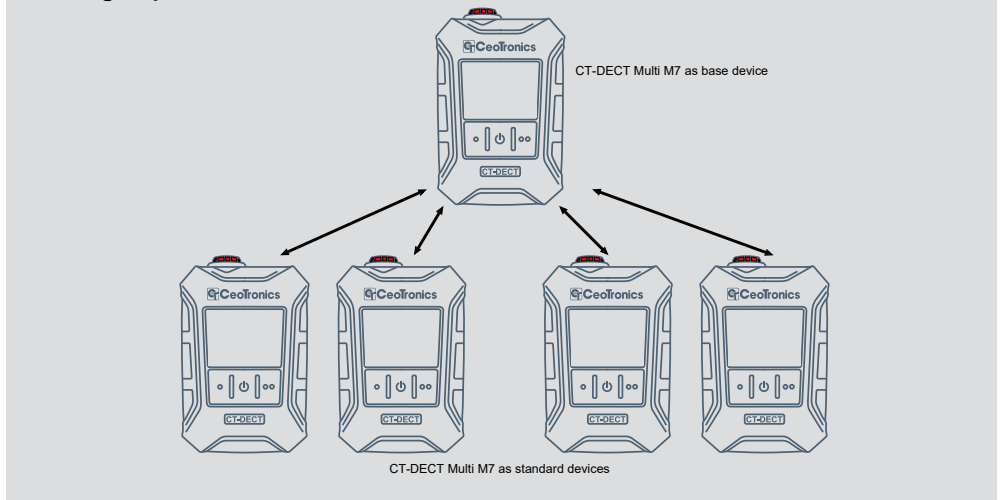

Depending on the software it is equipped with, the CT-DECT Multi M7 offers various profiles made for different use cases and roles.

## NOTICE

All DECT devices mentioned in this manual must be approved for use with Plasser & Theurer.

CT-DECT Multi M7s approved for this use are labelled 'S-7.5.41C'.

CT-DECT headsets that are approved for this use are labelled 'S-7.5.42A'.

### 3 Applications

The CT-DECT-Multi M7 can be used in various application scenarios. Different software profiles can be selected for this purpose.

Only the STANDARD profile is described here.

For information on the use of other profiles, please refer to the corresponding operating manual.

#### 3.1 Application: DECT group consisting of CT-DECT Multi M7

In this scenario, a DECT group consists exclusively of CT-DECT Multi M7.

The devices operating with the STANDARD profile subscribe to the device operating with the BASE profile. This allows DECT groups with up to 5 participants to be formed.

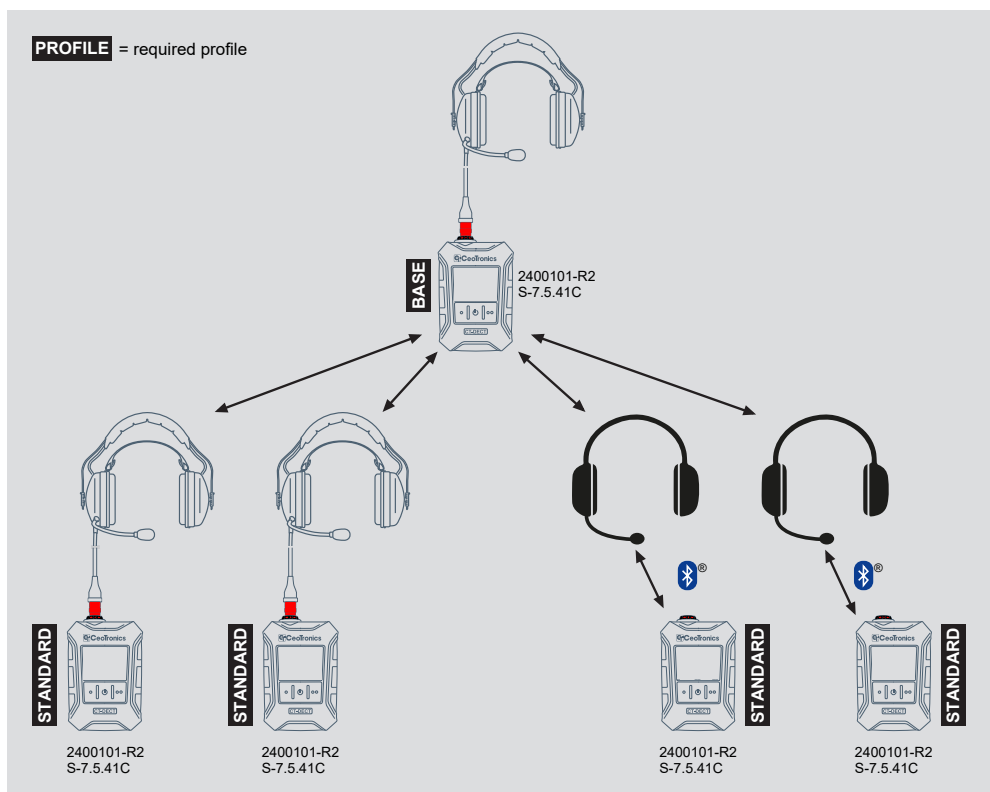



### 3.2 Application: DECT group with CT-DECT Case M7

In this scenario, the basic device of the DECT group is a CT-DECT Case M7. The CT-DECT Multi M7s operating with the STANDARD profile are subscribed to the CT-DECT Case M7.

This way, DECT groups with up to 12 subscribers can be formed and connected to an external infrastructure.

The following picture shows a sample configuration:

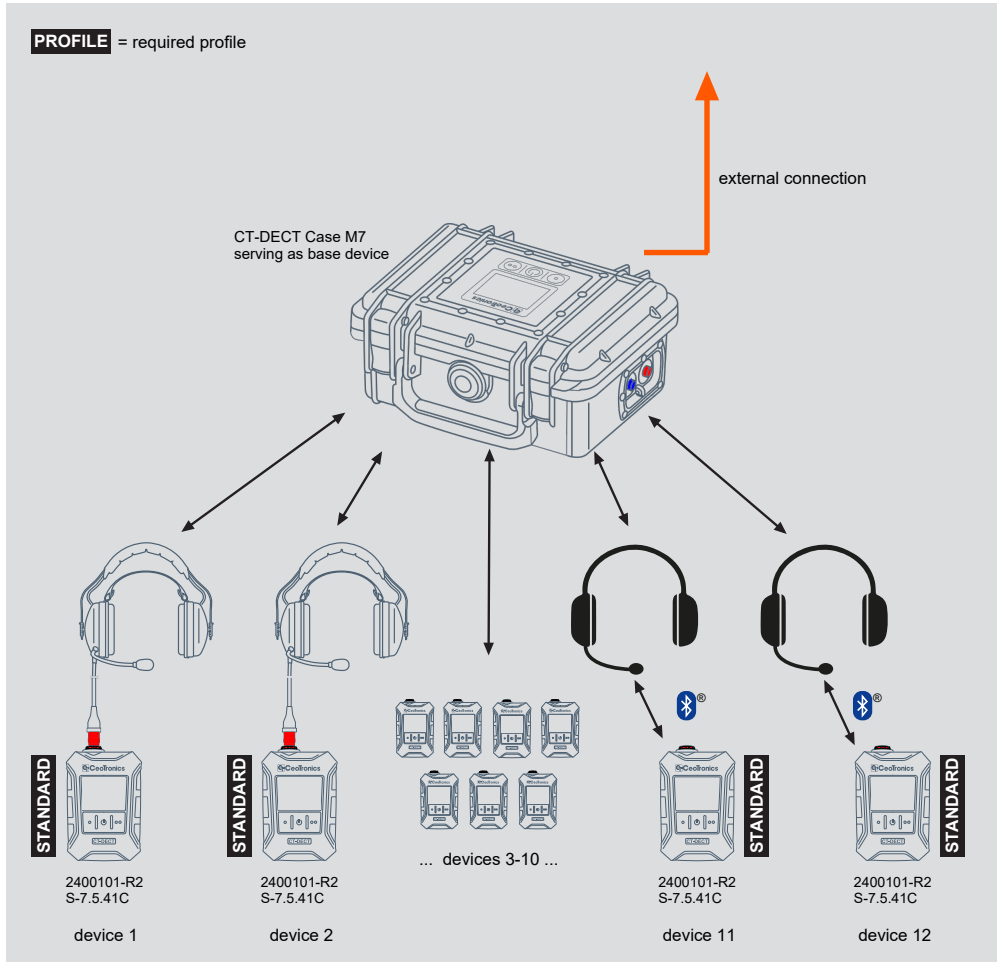

## 4 Operation

### 4.1 Controls

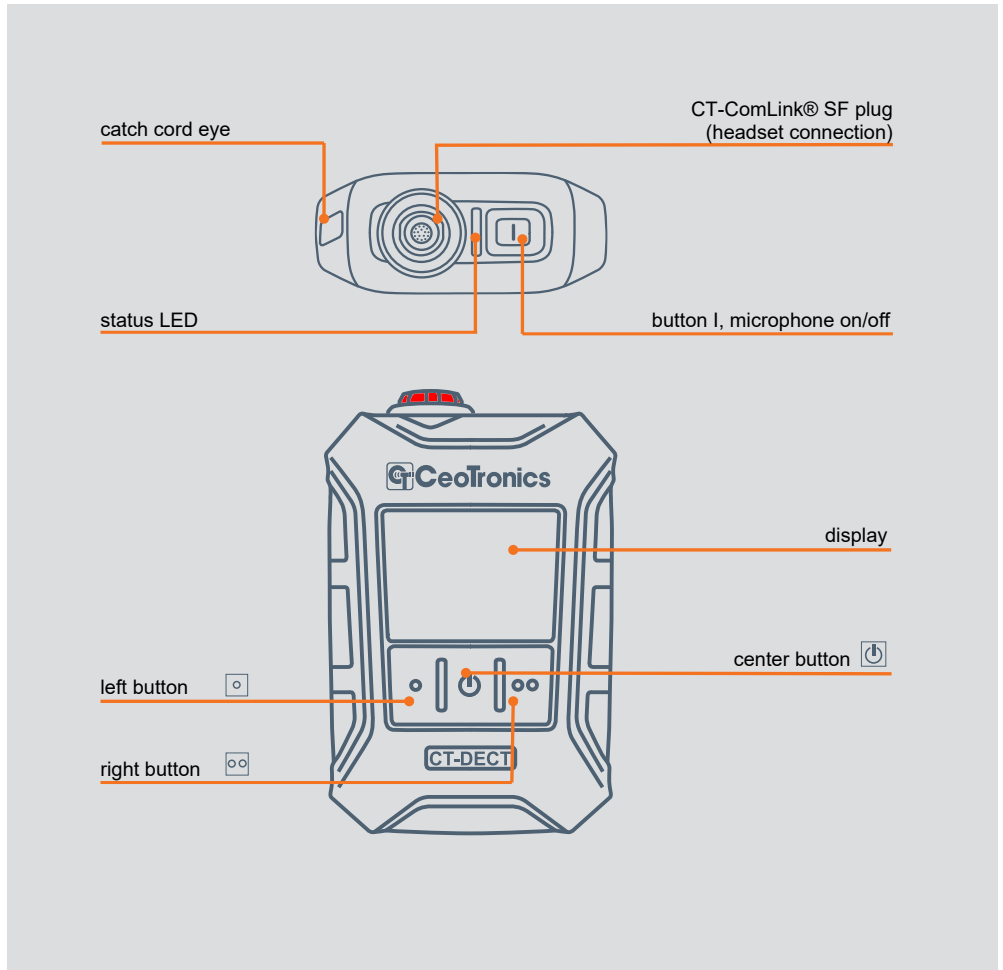

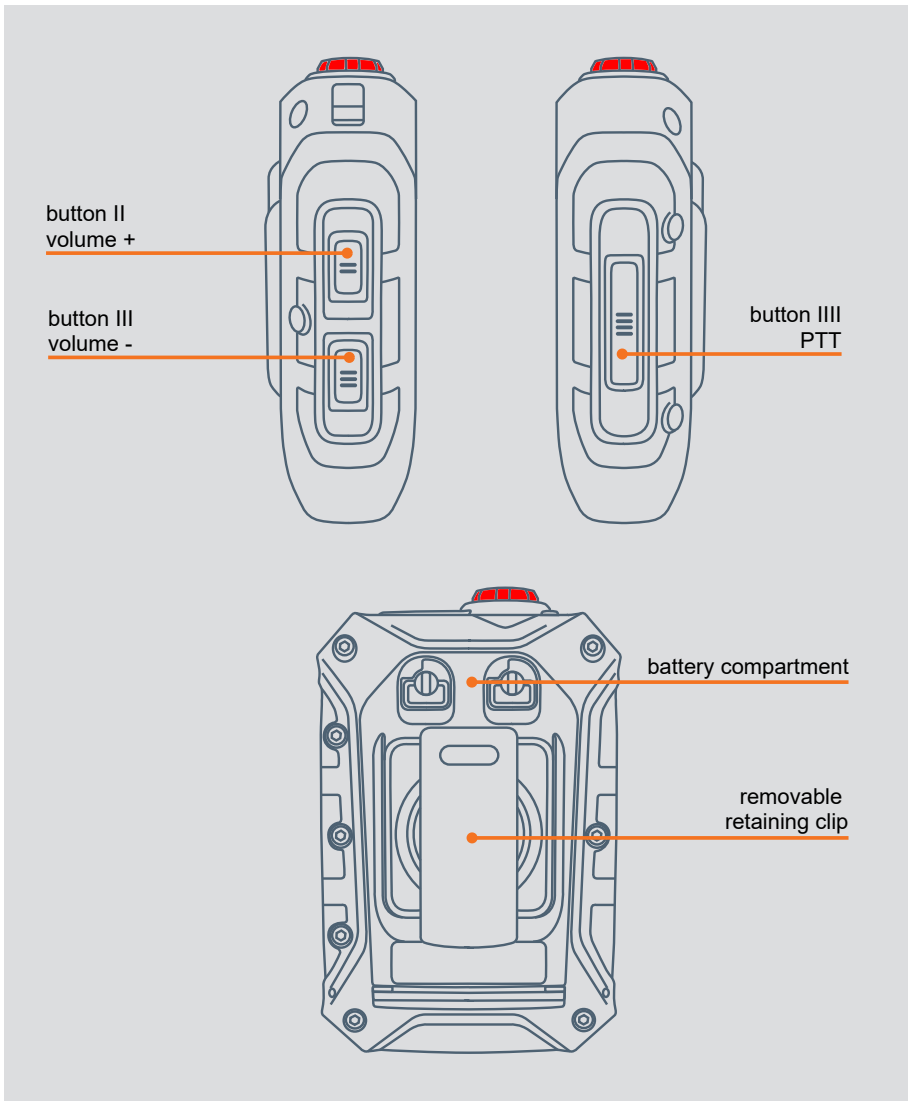

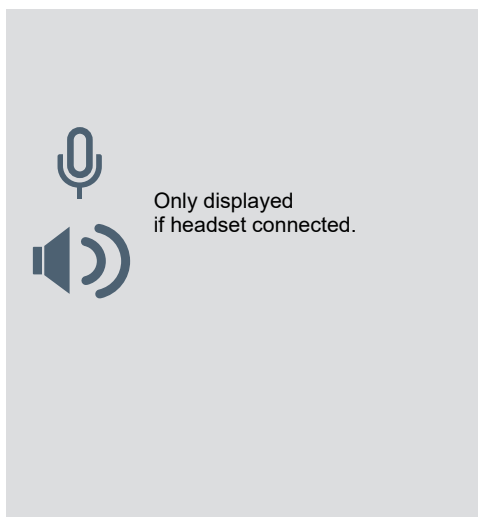
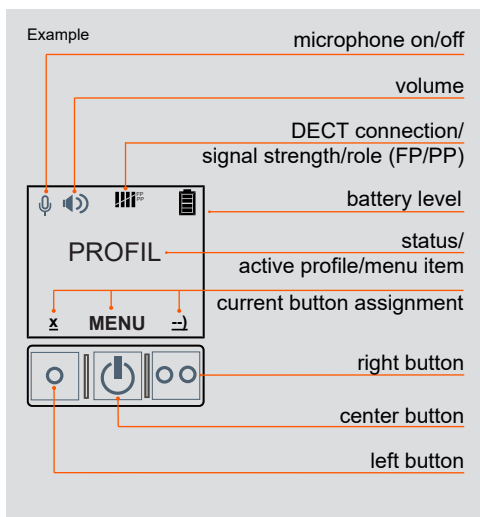

## 4.2 Plug connectors

Ensure careful handling of the plug connectors.

### 4.2.1 Connecting

#### Step 1

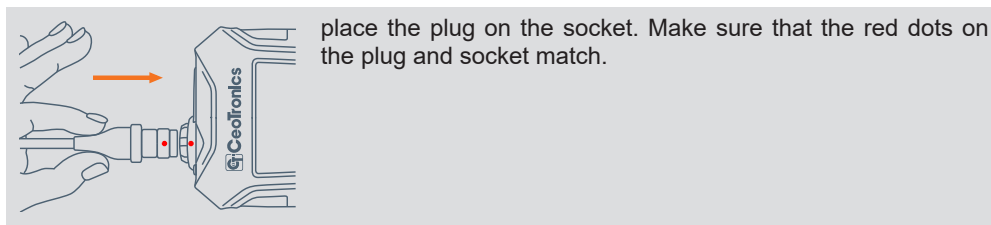

#### Step 2

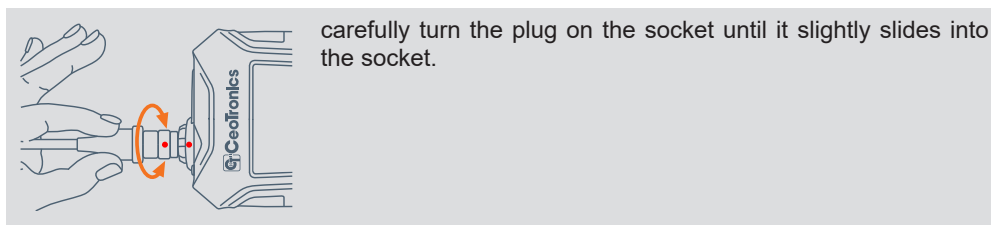

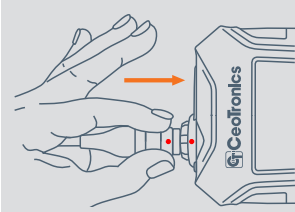
**Step 3**

press the plug into the socket until you feel it click into place.

## 4.2.2 Disconnecting

To release the plug grip it as close as possible to the socket:

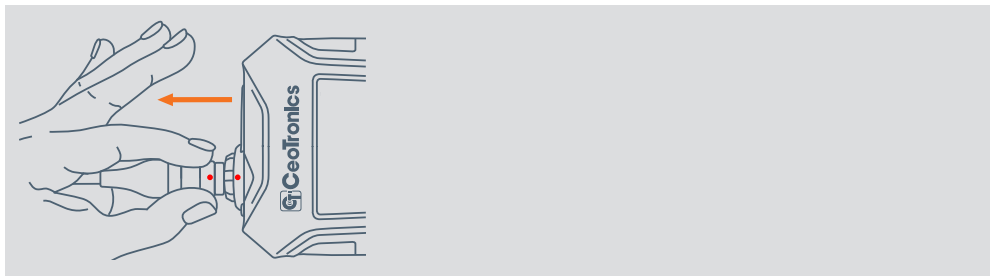

Avoid movements as shown in the following illustrations.

### NOTICE

Improper handling can damage the connector. The locked connector may neither be twisted nor bent. Never pull on the cable to disconnect the connector.

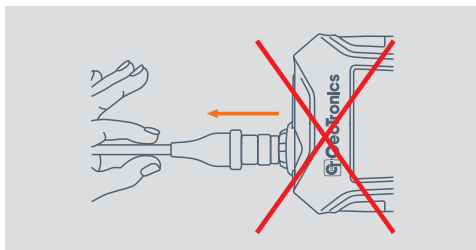
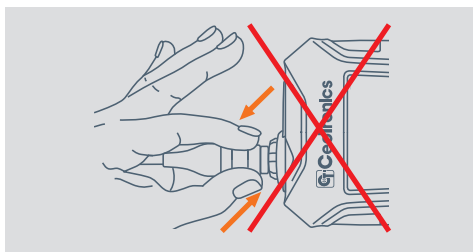
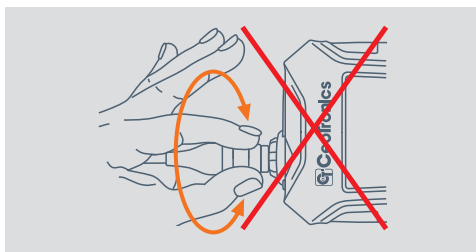

### 4.3 Power on



Press the center button until the display is active. The currently set profile appears on the display.

### 4.4 Power off



Press and hold the center button until SHUTDOWN appears on the display - press again to confirm.

### 4.5 Muting the microphone

By default, the microphone of a connected headset is permanently active/open. This means that other users in the DECT group can always hear you.

If you do not want to be heard all the time, you can mute the microphone.

To mute the microphone of the connected headset, press button I.

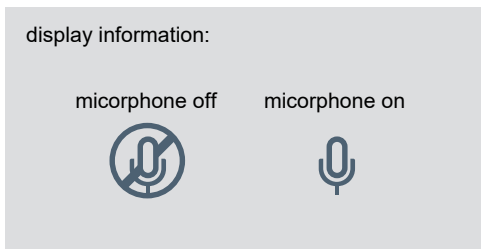
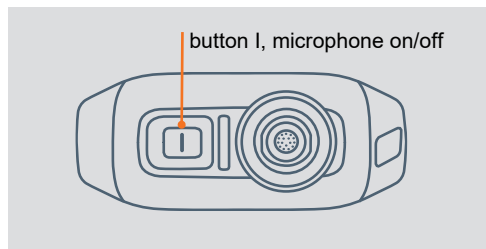

## 4.6 Earpiece volume

There are 6 volume levels available. They can be selected using buttons II (volume +) and III (volume -). The display shows the volume levels in steps of two. The earpiece volume can be set to the 'off' by holding down button III (volume -) for a longer period of time.

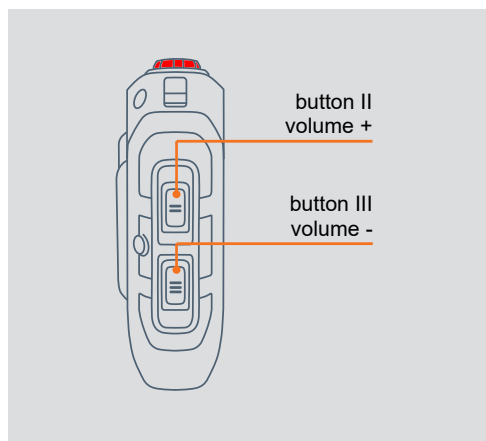

display information:



earpiece off



level 1-2



level 3-4



level 5-6



## 4.7 PTT function

The PTT button allows you to activate the PTT function of a radio device that is connected to the DECT group.

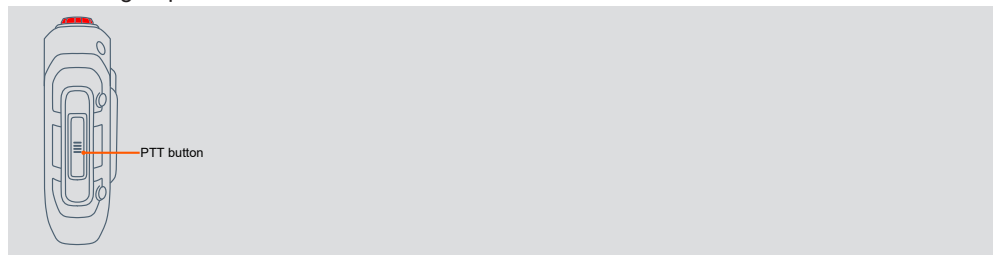

The connection is established, for example, via a CT-DECT Case M7:

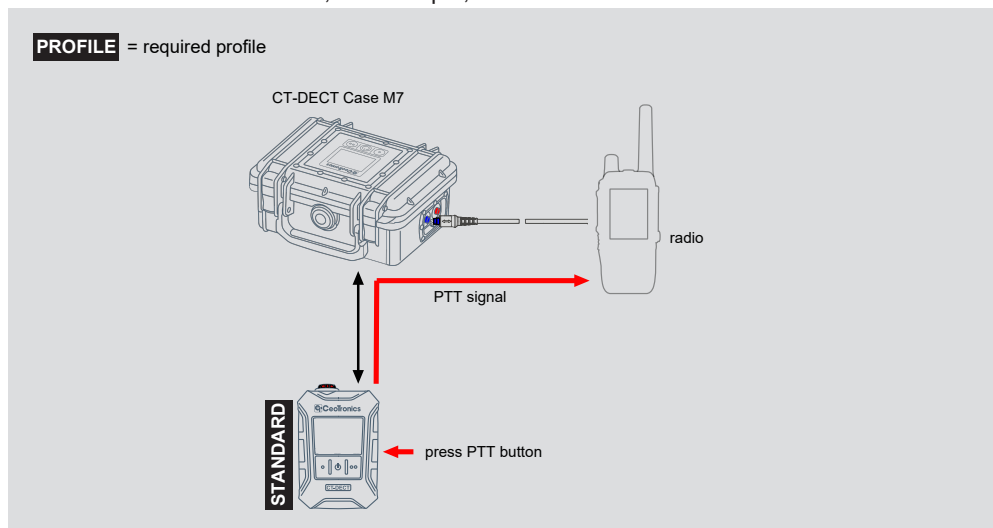

As long as the PTT button is pressed, the user can speak into the radio circuit. Meanwhile, the user continues to hear the DECT group.

### NOTICE

If the microphone of the CT-DECT Multi M7 is muted, the PTT function can still be activated. As long as the PTT button remains pressed, the microphone mute function is cancelled.

### NOTICE

The behavior of the communication between the DECT group and the radio is strongly dependent on the configuration of the CT-DECT Case M7. See the operating manual of the CT-DECT Case M7 for further information.

## 4.8 Menu control

### Enter menu

Press and hold the center button for 2 seconds to enter the menu.

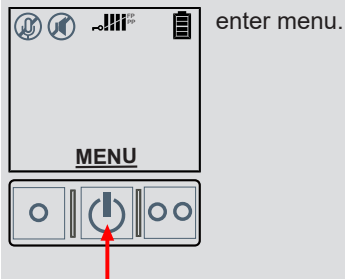

### Navigation

Use the three available buttons to navigate through the menu. The corresponding function of the buttons is shown above it on the display.

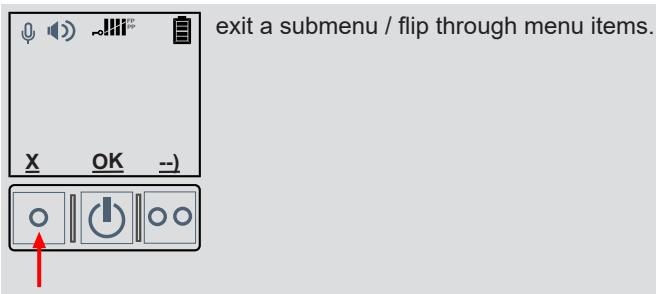
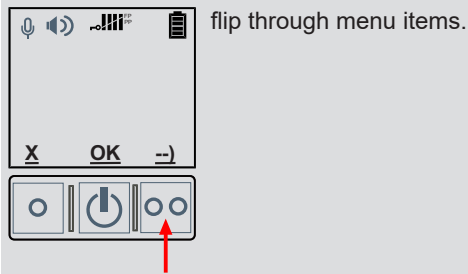

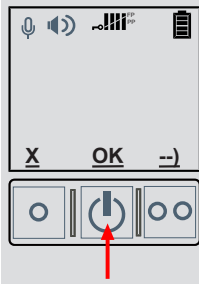

confirm selection.

## 5 Changing the profile

If the wrong profile is set, you can change it as follows:

### 1. Power off

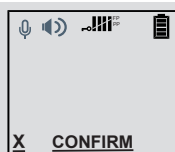

- press and hold the center button until SHUTDOWN appears on the display.

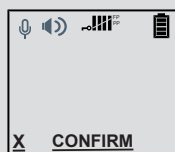
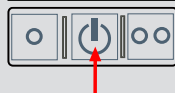

- press the center button one more time to confirm.

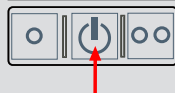

### 2. Switch on the device and start profile selection



- press and hold the center button and the left button simultaneously until PROFILE appears on the display.

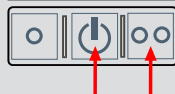

- press the center button one more time to confirm.

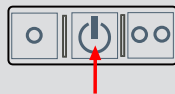
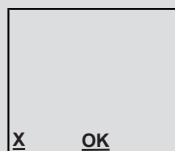

### 3. Select a profile



- use the right button to flip to the desired profile.

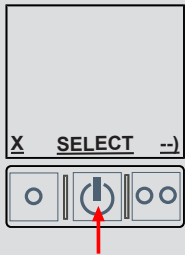

- press the center button to confirm your selection.

### 4. Confirm the profile change

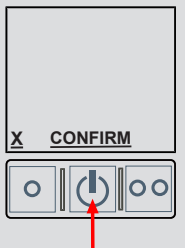

- press the center button one more time to confirm the change.

## NOTICE

The device will then restart. All settings are reset.  
After a profile change, all previously subscribed CT-DECT Multis M7 must subscribe again.

## 6 Menu

The following diagram shows all menu items available in BASE profile. Highlighted menu items are only available under certain conditions (see legend).

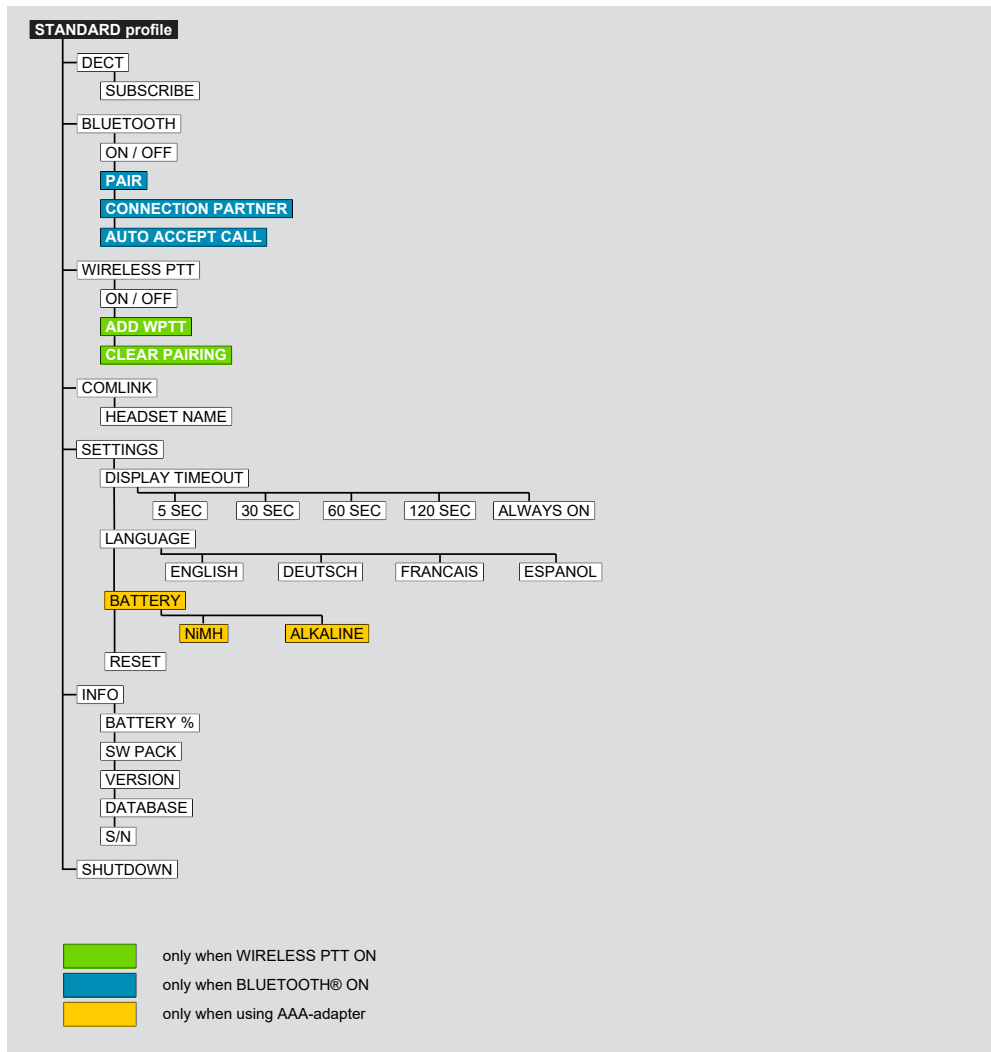

## 7 Subscribing DECT

Perform the steps quickly one after the other to avoid a timeout.

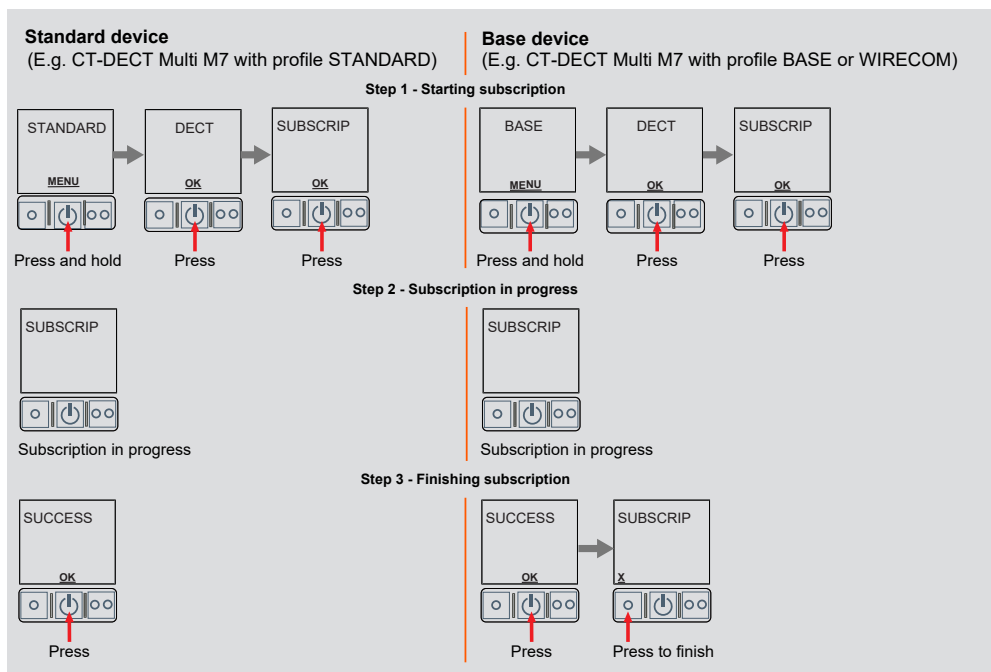

If you want another device to subscribe to the DECT group directly afterwards, see Subscribing consecutively [▶ 24].

### NOTICE

Do not switch off already subscribed devices while a subscription process is still running. A switched off device can be overwritten during a new subscription process.

If it is unclear which and/or how many devices have already been subscribed, we recommend deleting all devices subscribed to the base unit via the SETTINGS - RESET menu and restarting the subscription process for all desired devices.

### NOTICE

If you want to subscribe several standard devices (PP) to one base device (FP), make sure you only subscribe one device at a time. Do not try to subscribe several devices at the same time.

### 7.1 Subscribing consecutively

After a successful subscription, further CT-DECT devices can subscribe immediately.

After successful subscription the display in the CT-DECT Case M7 returns to the SUBSCRIPTION menu item ; step 1 on the base station has already been completed and can be skipped.

Continue with step 2 for the next standard device.

### 7.2 Maximum group size

If a CT-DECT Multi M7 is used as the base device, you can subscribe up to 4 standard devices.

When attempting to subscribe a fifth standard device while all subscribed devices are switched on, the message CONNECTED appears in the base device.

If a fifth standard device is subscribed while a standard device that has already been subscribed is switched off, the switched off standard device is replaced by the newly subscribed standard device.





## 8 CT-WirelessPTT MIL

The CT-WirelessPTT MIL is a wireless operating unit that can be used for remote operation of the CT-DECT Multi M7.

### NOTICE

The CT-WirelessPTT MIL is not included in the scope of delivery of the CT-DECT Multi M7.

### 8.1 Controls

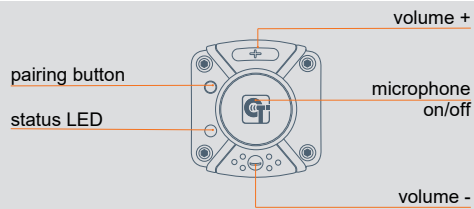

### NOTICE

Further information on the CT-WirelessPTT MIL can be found in the operating manual dok1790.

## 8.2 Switching on the WirelessPTT function

To prepare the connection with a CT-WirelessPTT MIL, the corresponding function must be switched on in the CT-DECT Multi M7.

To do this, use the WIRELESS PTT menu item:

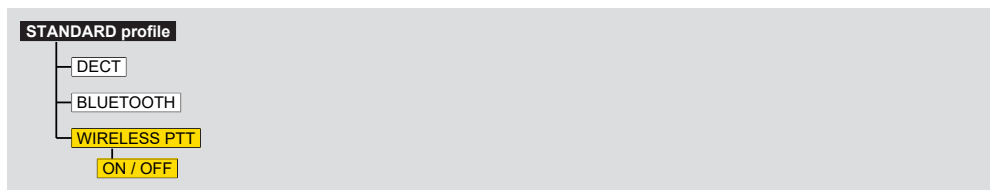

If there is no active connection to a WirelessPTT when the WirelessPTT function is activated, the WT symbol flashes on the display.

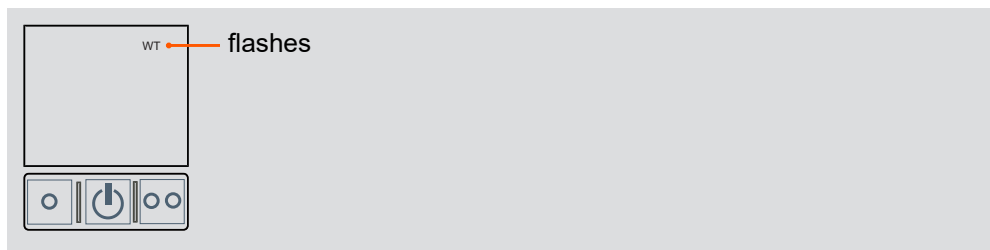

The WirelessPTT function can be switched off to disconnect the CT-DECT Multi M7 from the CT-WirelessPTT MIL without cancelling the pairing.

## 8.3 Pairing

To pair a CT-WirelessPTT MIL with a CT-DECT Multi M7 perform the steps quickly one after the other to avoid a timeout.

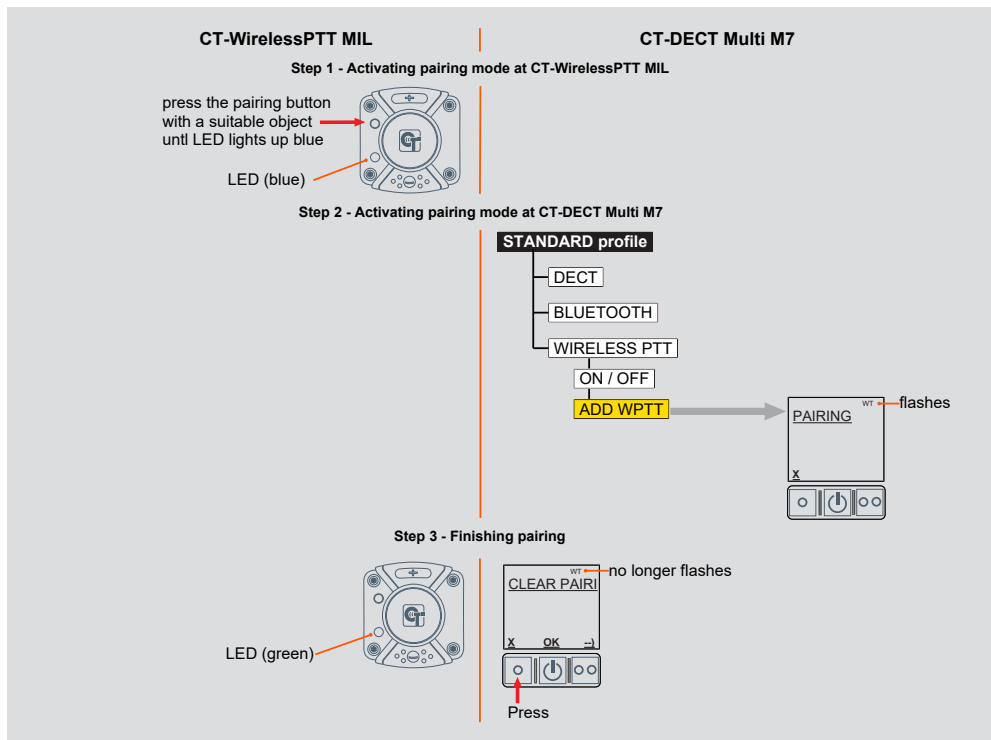

## 8.4 Delete pairings

You can delete all paired CT-WirelessPTT MIL from the memory of the CT-DECT Multi M7 via the menu.

This is helpful, for example, if several CT-WirelessPTTs have been mixed up or a CT-WirelessPTT has been lost.

To do this, use the CLEAR PAIRING menu item:

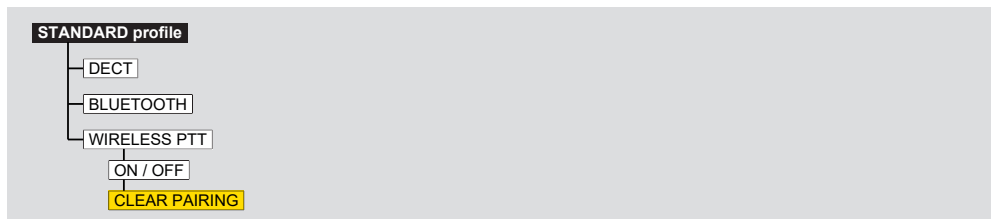

## 9 Bluetooth® connection

A mobile communication device such as a smartphone or tablet can be connected via the integrated Bluetooth® interface of the CT-DECT Multi M7 or a wireless headset (e.g. hearing protection headset with Bluetooth® function) can be used.

### NOTICE

Only one Bluetooth® audio connection can be established at a time. Either to a headset or to a communication device (e.g. smartphone).

If communication is established via the Bluetooth® device (e.g. a phone call via a smartphone), only the user of the CT-DECT Multi M7 with whom the Bluetooth® connection is established can make the phone call. In addition, this user listens to the communication from the DECT group. During the phone call, he cannot speak to the DECT group.

The other participants in the DECT group can neither hear the phone call nor speak into the phone call.

You can find a more detailed explanation of the communication options in the following sections.



## 9.1 Selecting a Bluetooth® device type

In order for a Bluetooth® connection to be established, the appropriate device type must be set:

Type of device	Examples
PHONE	smartphone, tablet, phone
HEADSET	hearing protection headset, telephony headset

You can set the device type via the CONNECTION PARTNER menu item:

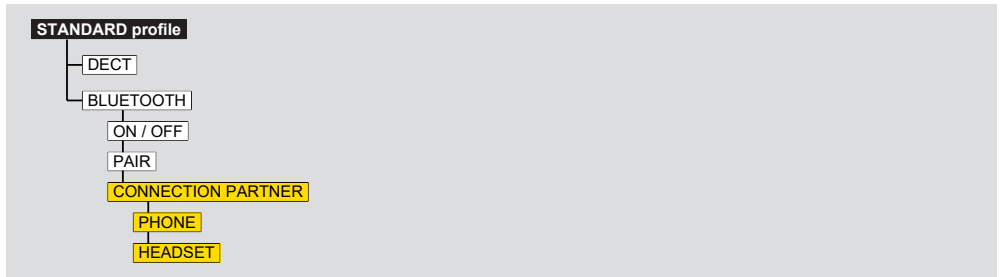

Default setting on delivery is PHONE.  
A change is retained even after a restart.

## 9.2 Connecting a Bluetooth® device (pairing)

Before a Bluetooth® device can be used in conjunction with a CT-DECT Multi M7, the devices must be paired.

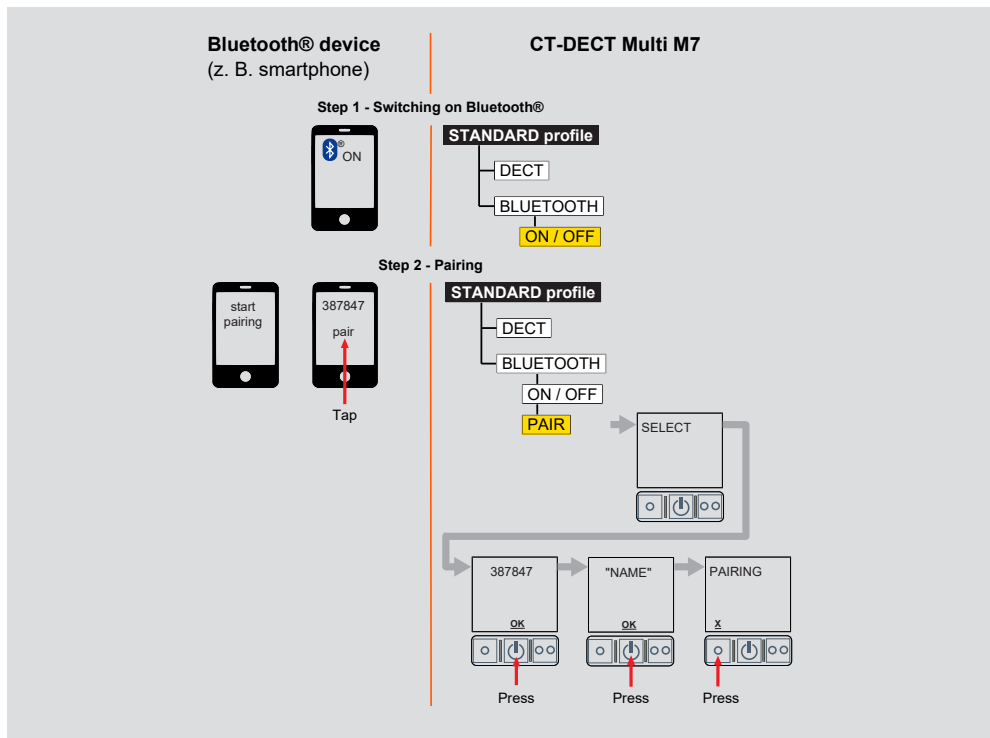

### NOTICE

For information on how to perform the pairing process with your Bluetooth® device, please refer to the manufacturer's user manual.



## 9.3 Phone call control

If a smartphone is connected via Bluetooth®, incoming calls can be accepted and rejected with the CT-DECT Multi M7 and existing calls can be ended.

Phone calls can also be accepted automatically as an option.

### 9.3.1 Answering an incoming call

When an incoming phone call is made, INCOMING CALL appears on the display of the CT-DECT Multi M7. You can then answer the call by pressing the respective button.

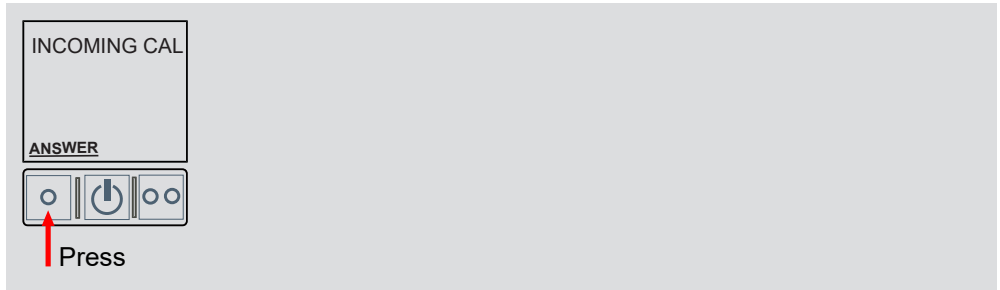

### 9.3.2 Rejecting an incoming call

If you do not wish to answer the incoming call, you can reject it by pressing the respective button.

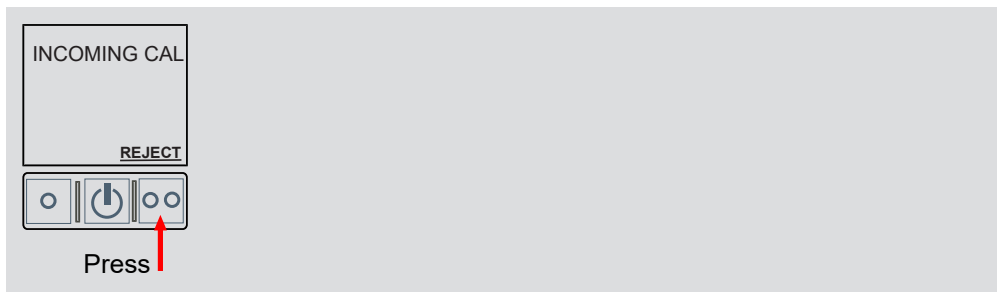

### 9.3.3 Ending an existing call

You can end an existing call via the menu.

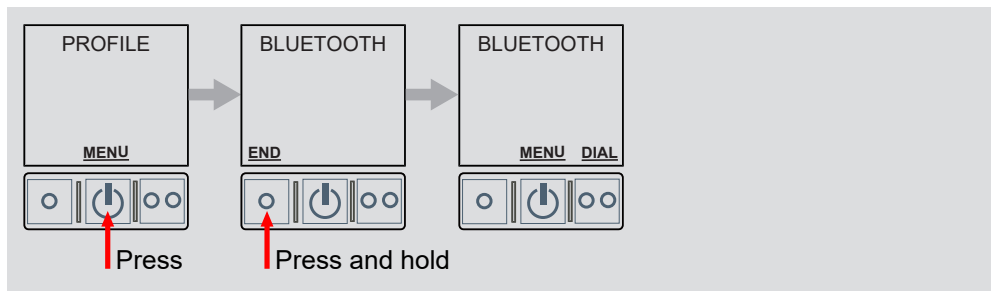

### 9.3.4 Activating automatic call acceptance

Incoming calls can be answered automatically if necessary. This feature is not active on delivery.

You can activate the function via the AUTO ACCEPT CALL menu item:

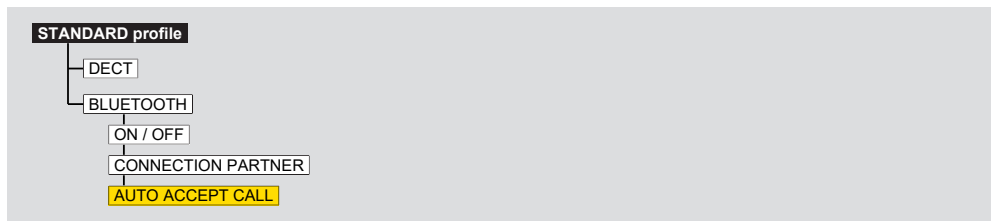



## 10 Internal power supply

Power is supplied by VARTA EasyPacks XL (LiPo).

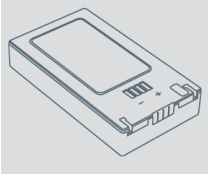

Alternatively, a special AAA adapter filled with three AAA cells can be inserted into the device.

### 10.1 Using AAA adapters

Instead of a battery pack, special AAA adapter filled with three AAA cells can be inserted into the device.

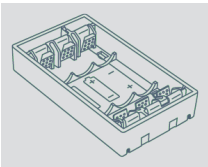

NiMH batteries or alkaline batteries can be used in the AAA adapters. The use of NiMH batteries is recommended.

The runtime depends to a large extent on the types of battery used.

The runtime depends to a large extent on the types of battery used:

- 3 AAA LR03 1.5V alkaline batteries
- 3 AAA HR03 1.2V NiMH batteries



### WARNING

Batteries and rechargeable batteries must not be mixed in the AAA adapters. Mixing batteries and rechargeable batteries can result in damage to the device.

### NOTICE

Batteries and rechargeable batteries must not be mixed in the AAA adapters. Mixing batteries and rechargeable batteries can result in damage to the device.

## Setting the type of battery

For an accurate calculation of the battery level, the device must know the type of battery used in the AAA adapters.

To set the battery type, use the BATTERY menu item:

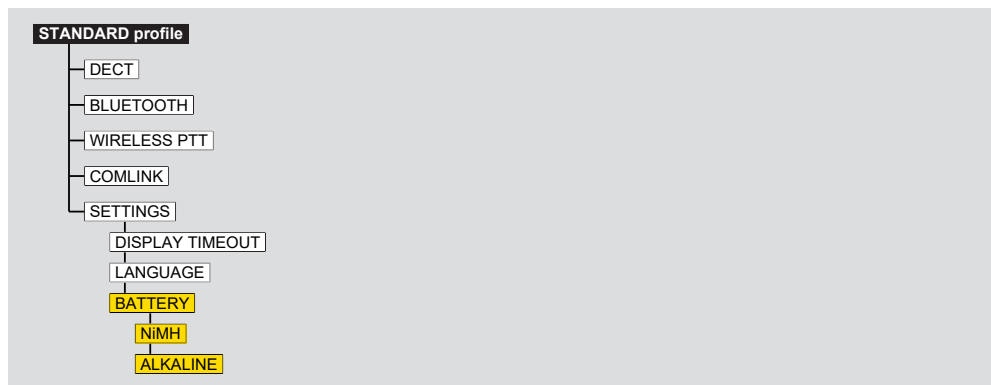

A change is retained even after a restart.

## 10.2 Changing the batteries / AAA adapters

### 1. Open the battery compartment

Open the battery compartment by turning the locks clockwise.



### 2. Change the batteries / AAA adapter

Remove the battery / AAA adapter from the battery department. When reinserting, make sure the electrical contacts of the batteries/battery adapters align with the contacts in the battery compartment.

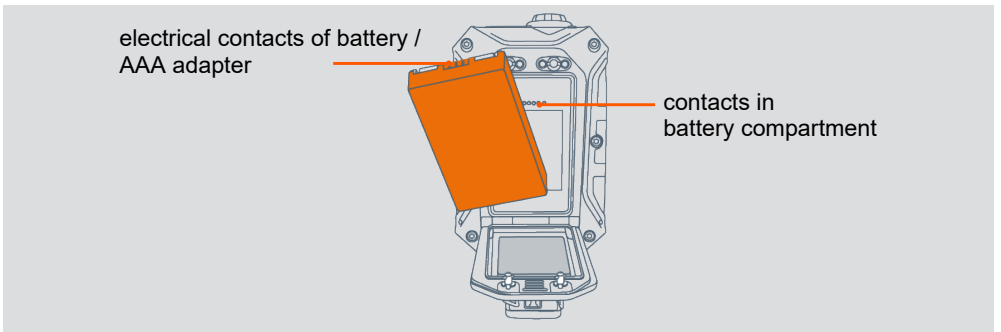

### 10.3 Runtime

The runtime of the CT-DECT Multi M7 may vary depending on:

- the actual ambient temperature
- the number of connected participants
- the use of the CLR connector
- the intensity of use (transmitting / receiving / standby)

The runtimes in the following table serve only as a rough guide.

#### Runtimes of the CT-DECT Multi M7 at 20°C

VARTA EasyPack XL	AAA NiMH-Akku Panasonic Eneloop Pro BK-4HCDE (930mAh)
up to <b>16</b> hours	up to <b>8</b> hours

Runtimes are shorter at lower temperatures. For example, a 10 % drop can be expected at 0 °C compared to 20 °C.

If rechargeable batteries/batteries with different filling levels are used, the runtime may also be shortened.



## 10.4 Battery level monitoring

Battery levels can be monitored on the display. Simplified icons can be seen permanently at the top of the display.

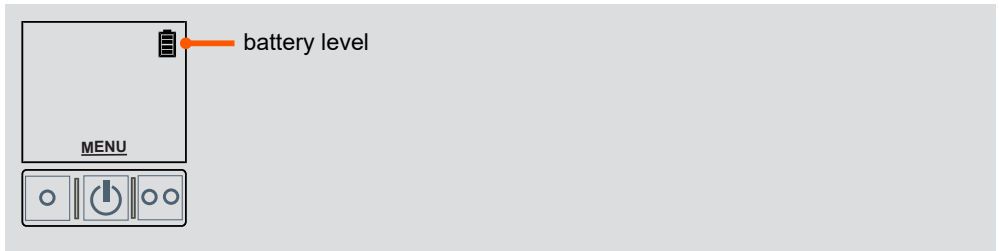

The exact remaining capacity can be called up in the menu.







The battery level calculations are calibrated to the following items:

Description	Short code	Part no
VARTA EasyPack XL LiPo battery pack	AKKU-VARTAEP	4024006
Panasonic eneloop AAA-NiMH battery	AKKU-AAA-ELP	4006504

The use of other types may lead to different results.

## 10.5 Visual battery status indicator (status LED)

The status LED visually indicates the remaining battery capacity. The assigned values only indicate the estimated remaining battery capacity. They cannot be converted to the remaining runtime without further ado, as this depends considerably on the usage scenario. If the LED flashes red, replace the battery pack/batteries.

	Status LED	Residual capacity
 <p>status LED</p>	 green	approx. 34 – 100 %
	 yellow	approx. 10 – 33 %
	 red	approx. 5 – 9 %
	 flashing red (2 sec cycle)	approx. < 5 %
	 flashing red (200 ms cycle)	shutdown imminent

## NOTICE

Batteries and rechargeable batteries must not be mixed in the AAA adapters. Mixing batteries and rechargeable batteries can result in damage to the device.

## 10.6 Acoustic battery warning

When the battery is low, the CT-DECT Multi M7 emits acoustic warnings. These are tones and voice announcements.

State of charge	Acoustic signal / voice announcement	Repetition cycle
0%	BEEP-BEEP – internal battery state – replace battery immediately	30 sec.
undervoltage	BEEP-BEEP – internal battery state – replace battery immediately	10 sec.

## 10.7 Automatic shutdown in case of undervoltage

To prevent uncontrolled switch-off, the device shuts down automatically if the battery voltage is too low. This switch-off is indicated by the scrolling text UNDERVOLTAGE and a countdown in the display.

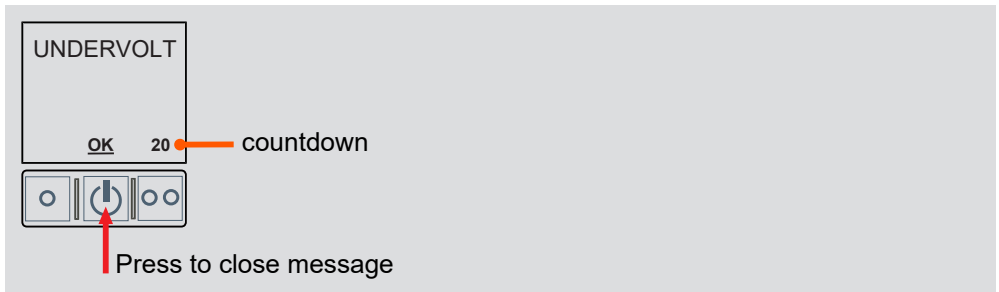

## 11 Accessories

Description	Short code	Part no
CT-WirelessPTT MIL, raised button	WLPTT-MIL-24-E	4008034
CT-WirelessPTT MIL, low button	WLPTT-MIL-24-F	4008035
CT-WirelessPTT MIL, button low & low-noise	WLPTT-MIL-24-FS	4008033
Black bag, for MOLLE systems	TASCHE-MULTIM7	4035141C
Camouflage bag, for MOLLE systems	TASCHE-MULTIM7	4035141-NSN
Orange bag with shoulder strap	TASCHE-MULTIM7	4035150
VARTA EasyPack XL	AKKU-VARTAEP	4024006
Single charging unit for VARTA EasyPack XL	LADE-VARTAEP1	4024008C
4-way battery charger for VARTA EasyPack XL	LADE-VARTAEP4	4024004
AAA adapter for three AAA cells	BATADAP3-AAA	4024005





## 12 Maintenance and care

### 12.1 Inspecting devices

Routinely inspect your CeoTronics devices, especially cables and connectors, for damage and wear and have them repaired, if necessary.

### 12.2 Cleaning

Clean your CeoTronics device with a suitable cloth moistened with clean water. If necessary, you can also use a mild soap solution, e.g. in the form of a hand dishwashing detergent or the following cleaning agents:

- Sterillium® classic pure
- Sterillium® med
- Bacillol® plus

Clean the contacts of the plug connectors with a commercially available contact cleaning agent.

# 13 Labeling

## Outside

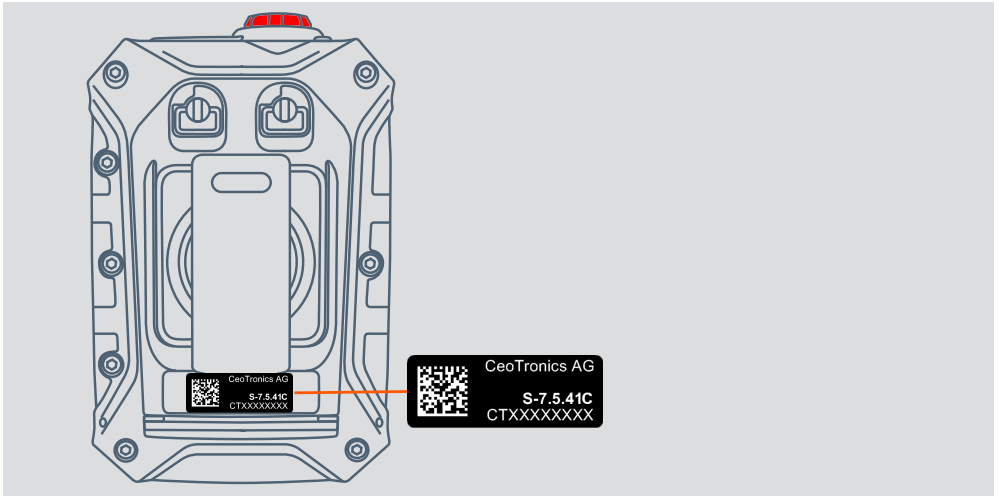

## Inside

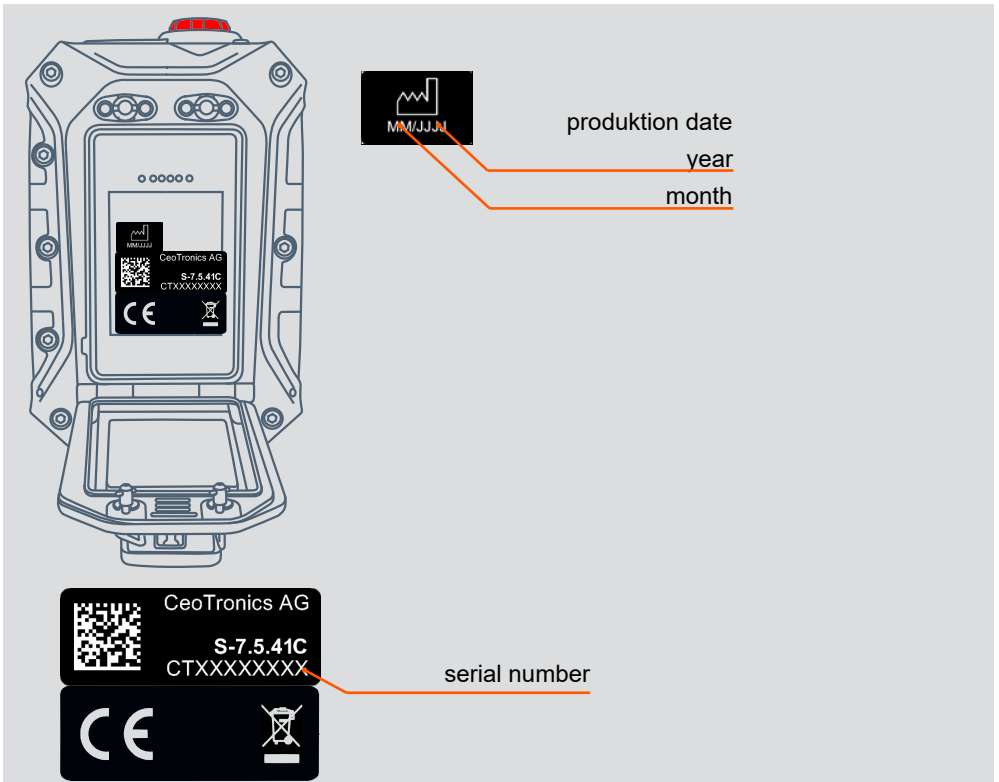

## 14 Abbreviations and terms

Abbreviation/term	Explanation
AAA	Battery and rechargeable battery size micro
BT	Bluetooth®
CT-ComLink® SF	SF = Standard mechanical coding „F“ - is usually used to connect a headset
FP	Fixed Part – DECT Basis-Gerät auf das mobile DECT-Teilnehmer (PP) eingelernt werden können
LiPo	Lithium polymer
NiMH	Nickel metal hydride
PP	Portable Part - mobiler DECT-Teilnehmer, der auf DECT Basis-Geräte (FP) eingelernt werden kann
PTT	Push-to-Talk
S/N	Serial number



## **CeoTronics AG**

Audio · Video · Data Communication

Adam-Opel-Str. 6  
63322 Rödermark (Deutschland)

Tel: +49 6074 8751-0  
Fax: +49 6074 8751-676-265  
E-Mail [verkauf@ceotronics.com](mailto:verkauf@ceotronics.com)

